

TOGETHER WE CREATE POSSIBILITIES



2021 China-Malaysia Technology (EV components) Cooperation Seminar

8th June 2021

Hosted By: ShenZhen Stock Exchange, Bursa Malaysia

Technology companies must understand the dynamics of evolving markets and technologies. It is not just a matter of manufacturing breakthroughs; the selection of markets and technologies are equally important.

CHIEF EXECUTIVE OFFICER

EK TAN

Greatech Capabilities

Production Line System

- Being the lead in the factory automation solutions provider, we design production lines using top notch technology and processes based on our experience, talent and knowledge.
- We tailor our products and services to various industries whereby our major clients are from the Fortune 500 companies.

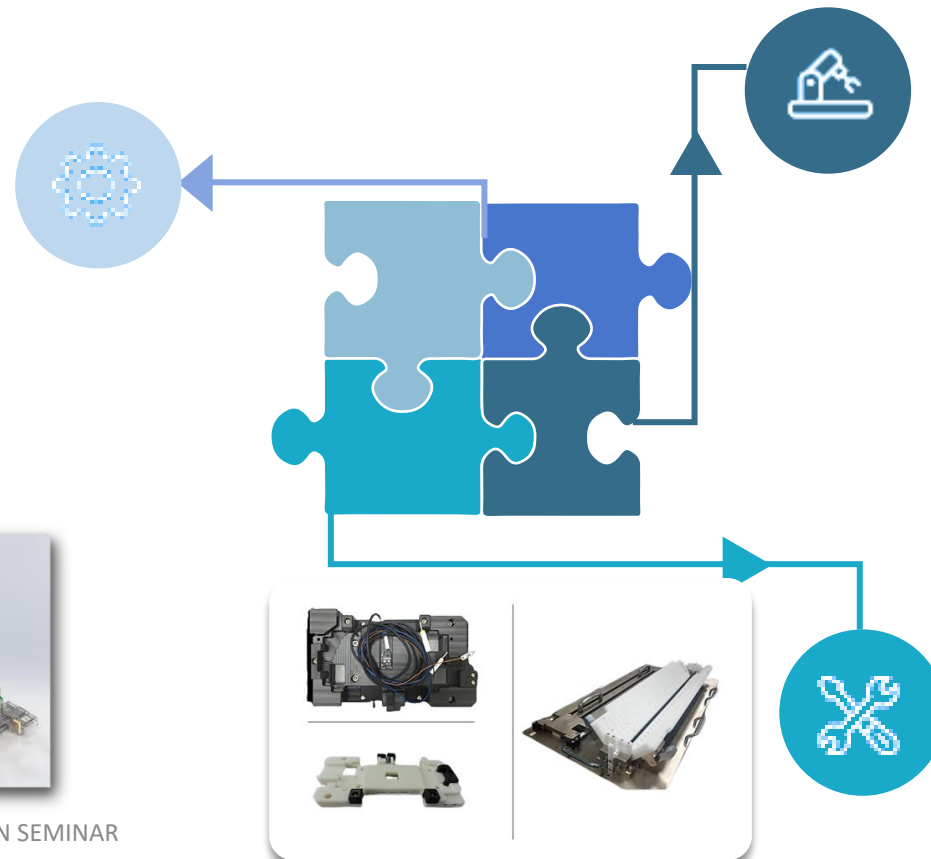
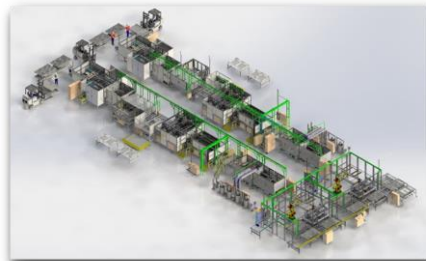

Single Automated Equipment

- Design and build the standard platform equipment by integrating automation technologies for various industries such as the semiconductor, battery and solar.

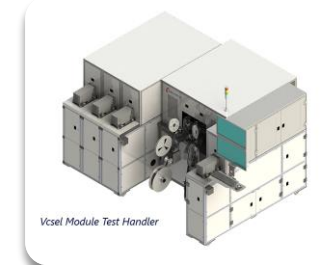

Spare Parts, Services and Upgrade

- Provides full service and support to existing customers with a focus on engineering solutions and customer satisfaction while giving the option for upgrade to maximize productivity and increase the speed of the equipment.

Financial Highlights

	Q1 2021	Q1 2020	3M 2021	3M 2020
Revenue (RM million)	95.14	52.74	95.14	52.74
Gross profit (RM million)	49.38	20.93	49.38	20.93
Gross profit (%)	51.09	39.69	51.09	39.69
PBT (RM million)	47.01	18.80	47.01	18.80
PBT margin (%)	49.41	35.65	49.41	35.65
PAT (RM million)	46.66	18.49	46.66	18.49
PAT margin (%)	49.04	35.06	49.04	35.06
Cash and cash equivalents (RM million)			312.82	232.25

Revenue By Segment

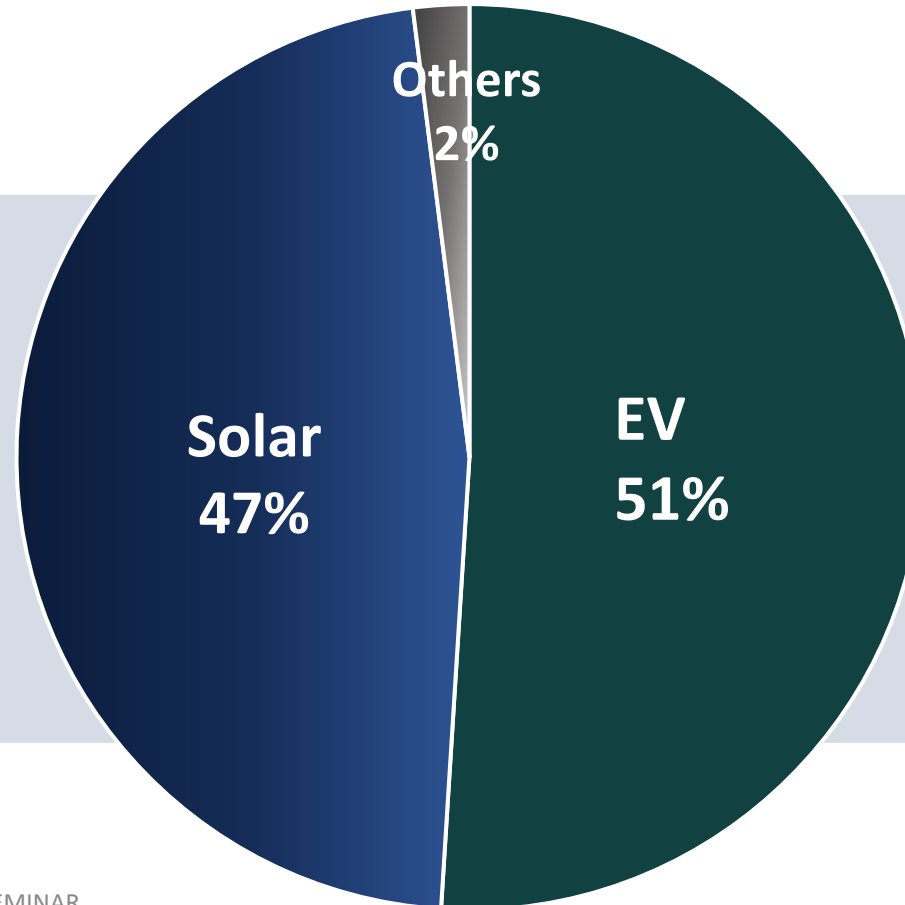

Established in 1997

Headquartered in Penang, MALAYSIA

Manpower

To date: 585 hc

Estimated 2021 manpower: +/- 800hc

50% comprises of engineers

Global Support

Malaysia, USA, China & Vietnam



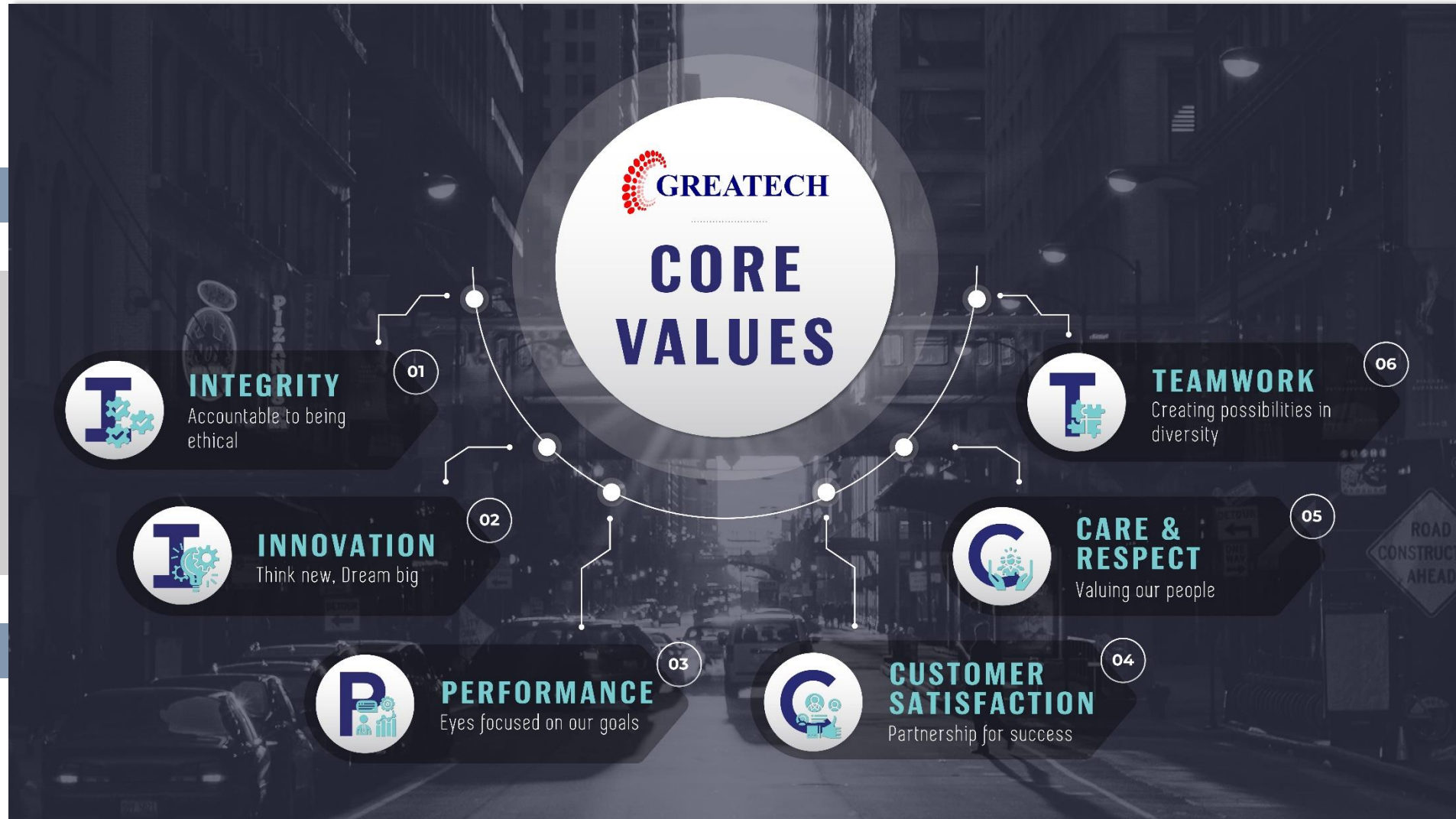

Greatech Strategic Plan

GROWING CORE PRODUCT

- Increase the market share
 - ✓ Solar
 - ✓ EV Battery
 - ✓ Semiconductor & Sensor
 - ✓ Life Science

PRODUCT & MARKET DIVERSIFICATION

- Emerging technology & emerging market

MERGER & ACQUISITION

- Strategic fit focused
 - ✓ EV Battery
 - ✓ Semiconductor & Sensor
 - ✓ Life Science

Greatech Success Drivers

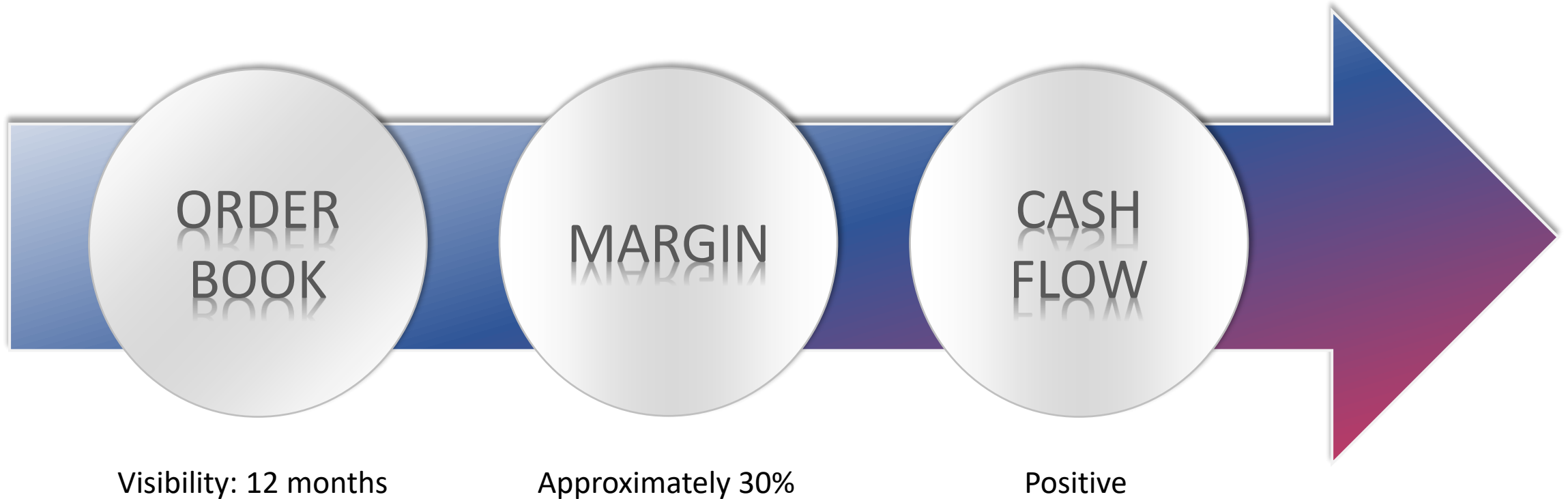

Greatech Industries

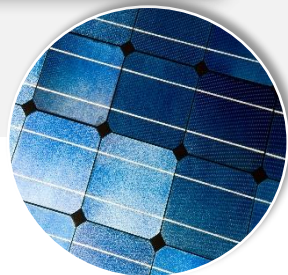
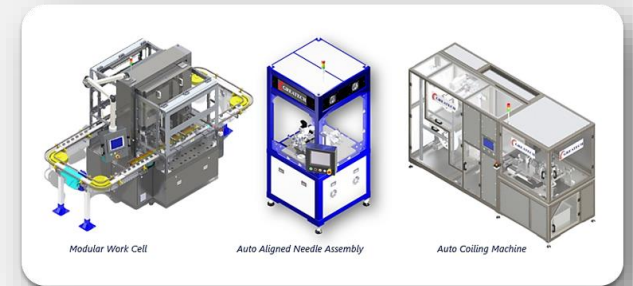
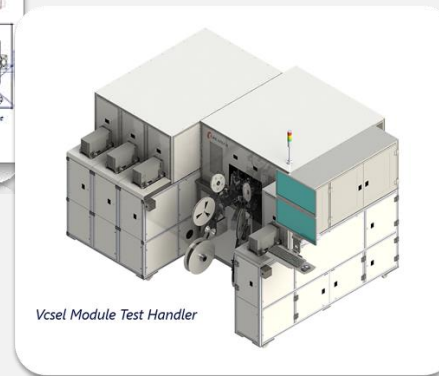
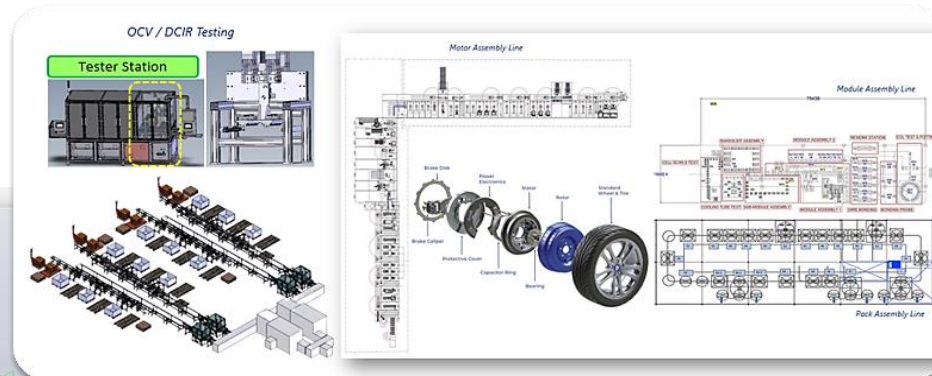

Solar



Energy Storage

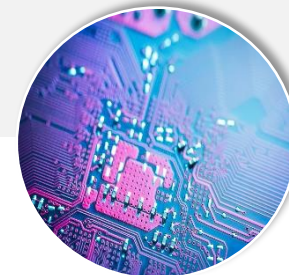

Semiconductor & Sensor



Life Science

2021 New Product

DEVELOPMENT PLAN



SUBSTRATE

- Completion status: 95%
- Target completion: Q1 2021
- Target for beta test: Q2 2021
- Processing Equipment



OPTICS

- Completion status: 90%
- Target completion: Q2 2021
- Target for beta test: Q3 2021
- Submicron Accuracy

Technology Roadmap

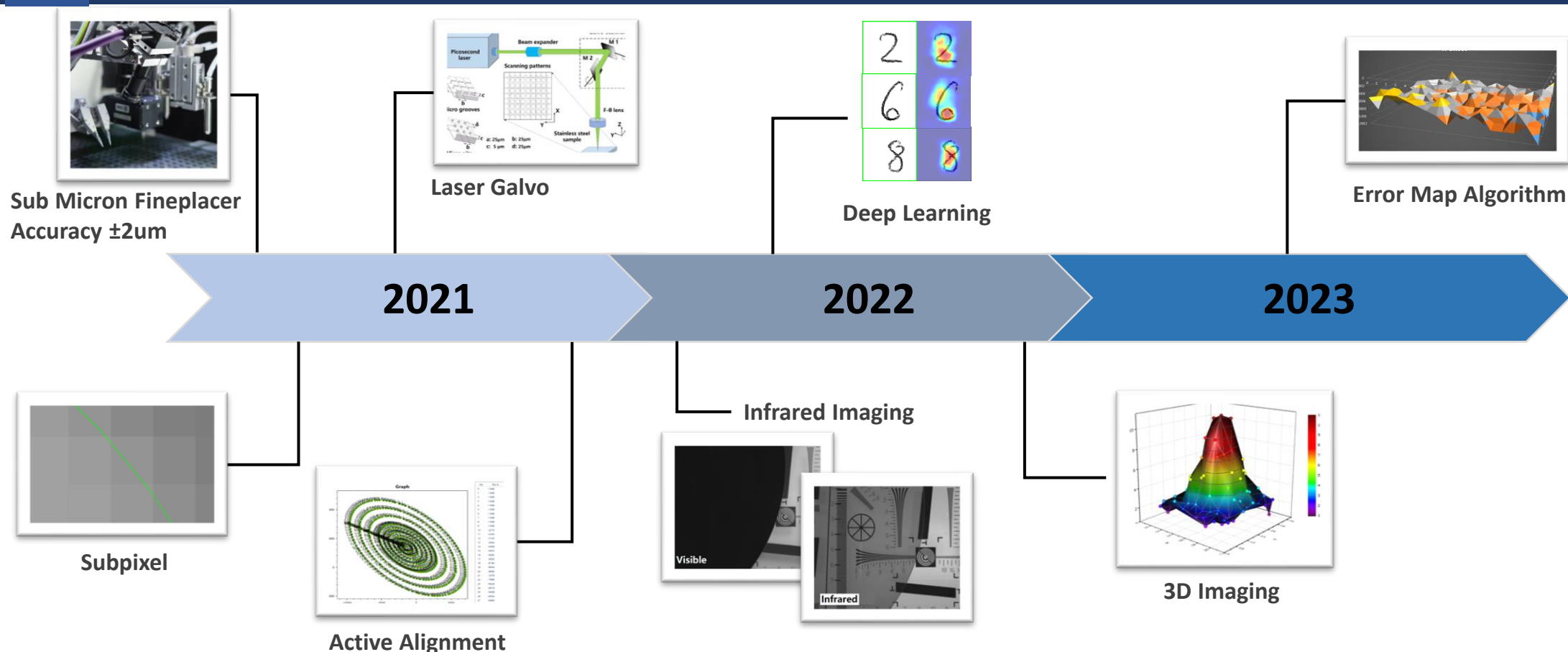

R&D Investments



EXPENSES PROJECTION

YEAR	AMOUNT (in RM)
2020	9 million
2021	12 million

Global Footprint

INTERNATIONAL MARKET

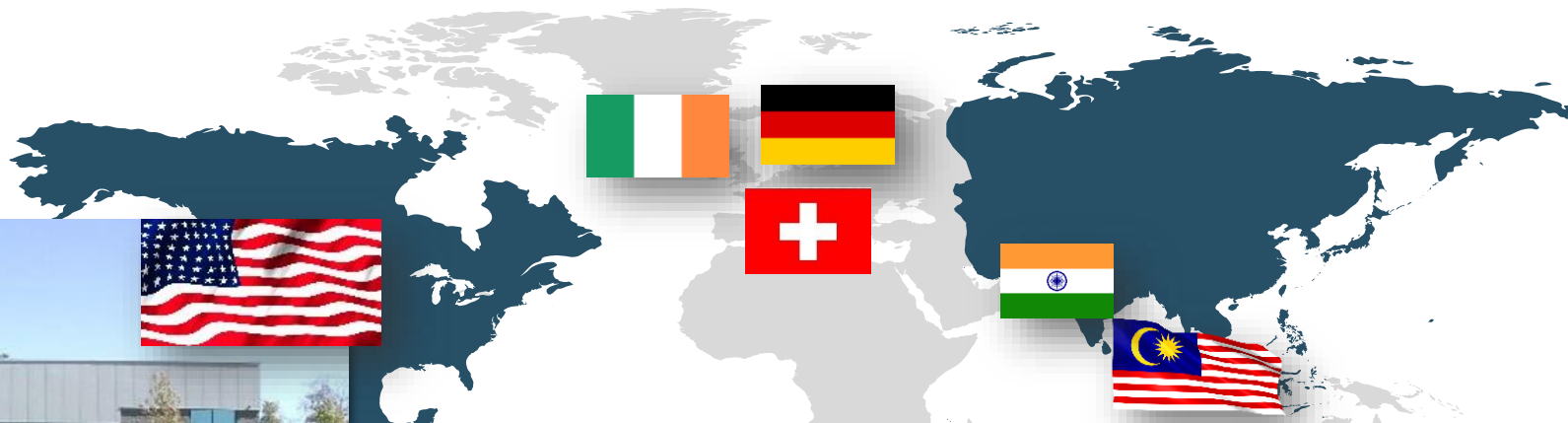

MICHIGAN – 16,000sq ft facility

Automotive	Life Science
General Manager & Sales Director have been hired	Sales Director pending for hiring

LIFE SCIENCE			LIFE SCIENCE & EV BATTERY
IRELAND	INDIA	SWITZERLAND	GERMANY
Sales office setup to complete by Q3FY21	Sales office setup to complete by Q3FY21	Hired Business Development Director	Sales office setup to complete by Q3FY21
Hiring of Sales Director for medical sector	Hiring of Sales Director for medical sector		

Capacity Investment

BATU KAWAN FACILITIES

		Batu Kawan (II)
TOTAL INVESTMENT	Land	RM 13.4 mil
	Building	RM 36.6 mil
	Equipment	RM 10.0 mil
	Machinery	RM 15.0 mil
	Software	RM 2.0 mil
	TOTAL	RM 77.0 mil
BUILT-UP AREA		230,000 sqft
PURPOSE		Design, assembly & admin.
PROGRESS STATUS		Construction starts in Feb'21



BATU KAWAN (II)

Global Talent Initiatives



MAKING LOCAL TALENT GLOBAL

LOCAL

Young Engineering Programme (YEP) Enrolment

2019 (35) | 2020 (45) | 2021 (120)

YEP Development Programme

Mechanical: 2mths/engineer
Software: 2.5wks/engineer

Talent Enrichment Programme

Annual Training: an average of 45hrs/engineer

Innovation Council

A platform to unlock technical skills and to expand capabilities



EQUIPPING LOCAL FOR THE LOCAL

INTERNATIONAL

Talent sourcing for the very best individuals
Individual with extensive market knowledge & expertise provide new way of entering potential/emerging market

Strengthening "diversity"
Cultivate alternative ways of thinking & approach in embracing global technology

Winning Business Through The Locals
Build, grow & expand business networks

SUCCESSION PLAN

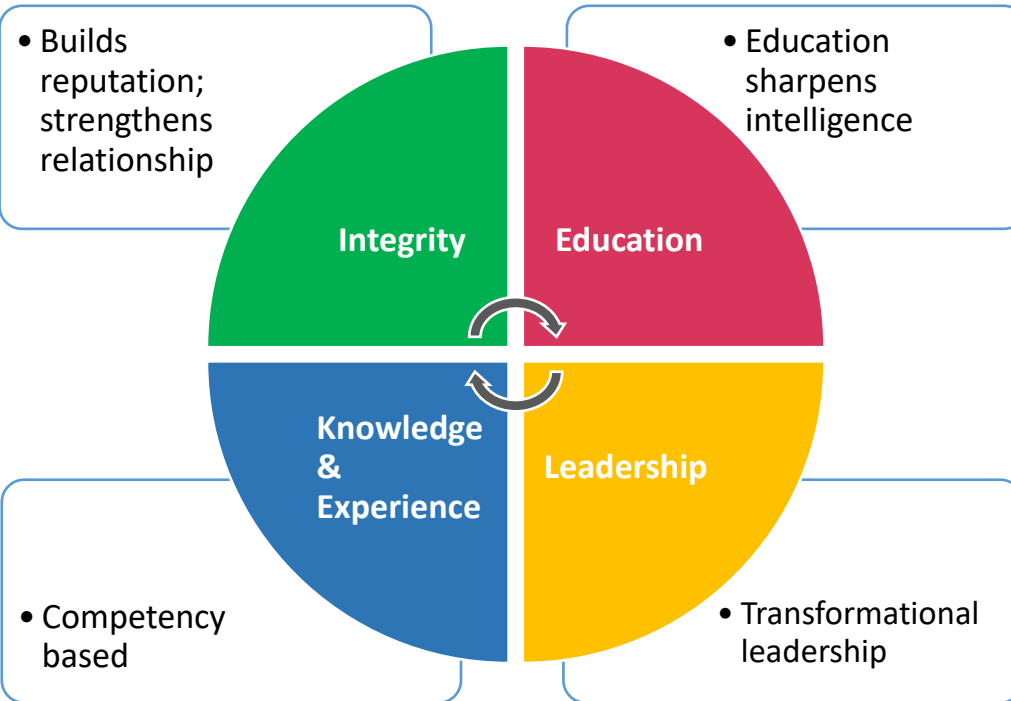

Casting A Positive Future

SCALE



Covid-19 Impact

ENABLERS & BARRIERS

Travel permit for overseas support (USA) has been fully granted throughout the MCO/CMCO period

Production operates at full capacity during this unprecedented crisis

Challenge faced on business matching in Malaysian and S.E.A region



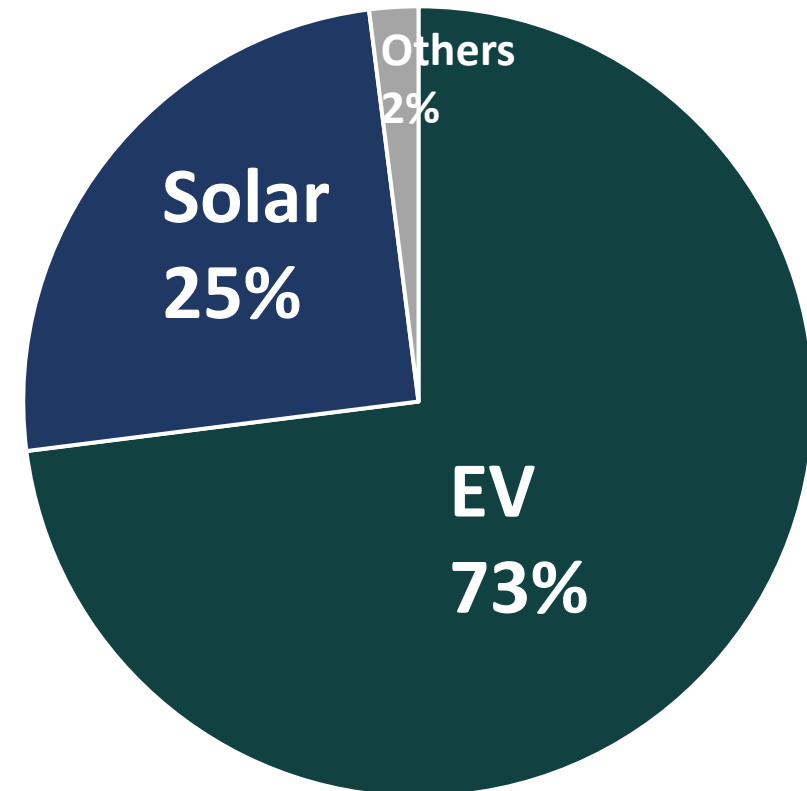

News Update

ORDER BOOK
RM293mil

Contributing Segments



Business Highlights

	SECTORS	EXISTING	TARGETING	HIGHLIGHTS
	SOLAR	1	N/A	Growing segment
	LIFE SCIENCE	1	3	Slow progress
	SEMICON & SENSOR	2	2	Slow progress
	EV BATTERY	4	4	Progressive growth with promising opportunity

TOGETHER WE CREATE POSSIBILITIES



THANK YOU